

# SPX4-Ex

# Serrure SPX4 sur porte battante en milieu Atex

Serrure certifiée ATEX - groupe II (2GD ; C II BT6)

Produit à remplacer

Serrures non identifiées

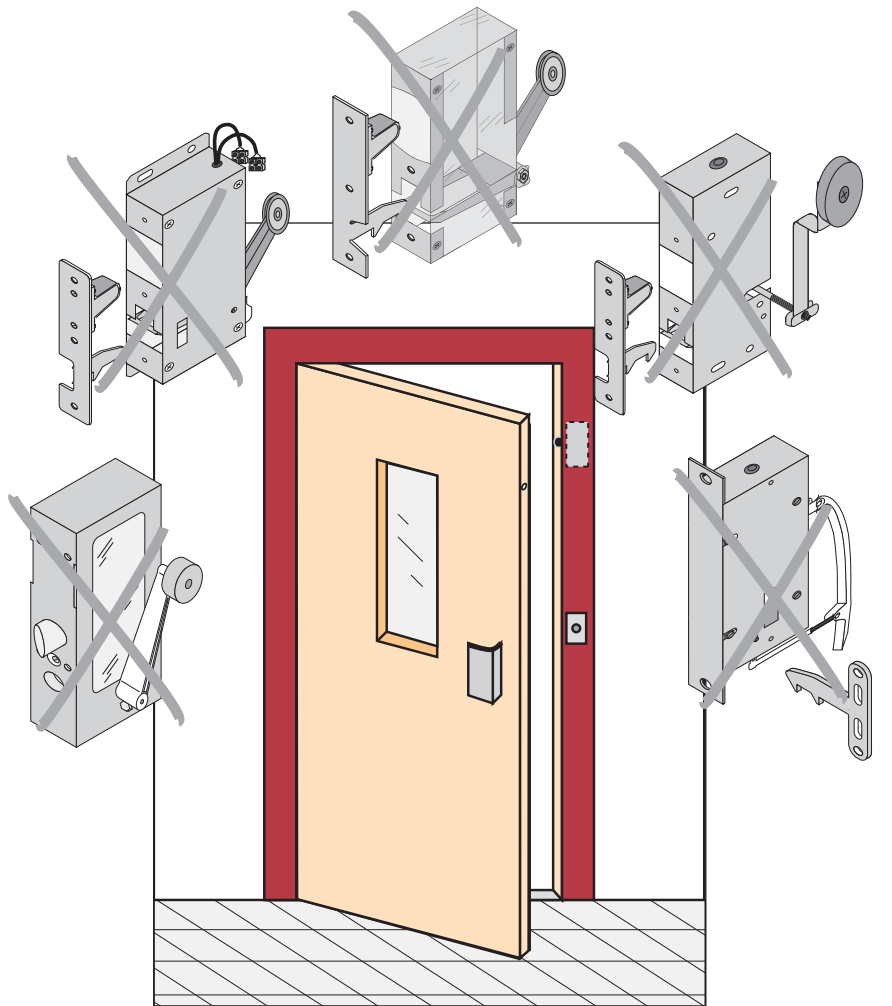

Produit de remplacement

SPX4-Ex/\*D (droite) (prudhomme S.a.)

SPX4-Ex/\*G (gauche)

Serrure certifiée ATEX - groupe II  
(2GD ; C II BT6)

Matériel optionnel :  
CP/SPX4/Ex (Calibre de perçage)  
CP/DV/SPX4/Ex (Calibre de perçage)

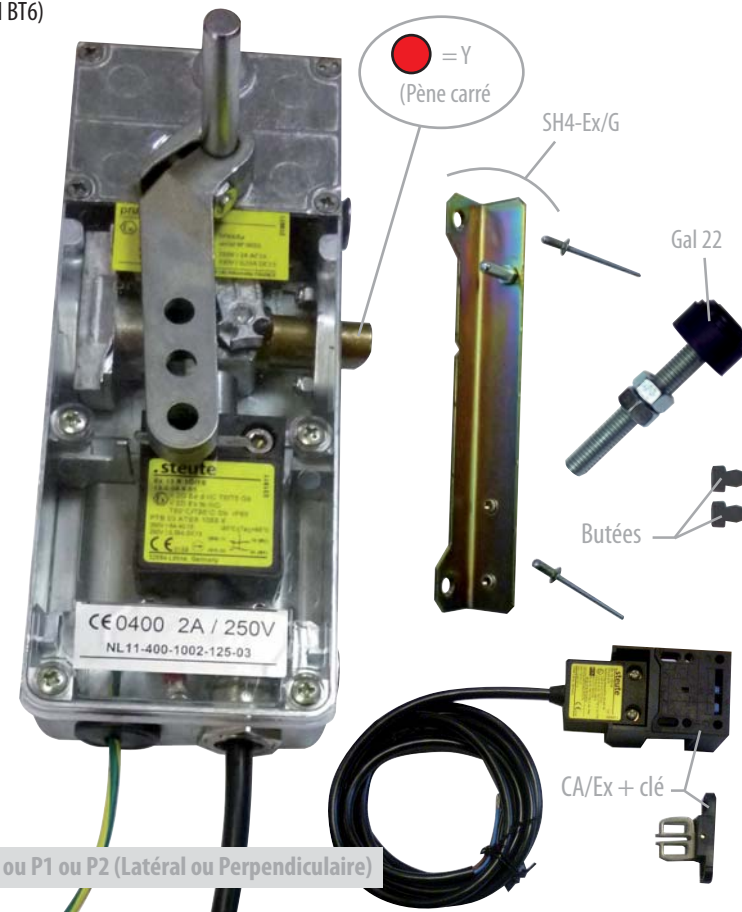

\* = Lk ou L ou P1 ou P2 (Latéral ou Perpendiculaire)

# Serrure SPX4 sur porte battante en milieu ATEX

# SPX4-Ex





Serrure certifiée ATEX - groupe II (2GD ; C II BT6)

réf. : SPX4-Ex/\*G

réf. : SPX4-Ex/\*D

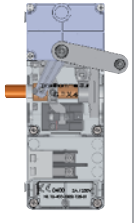
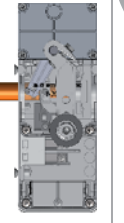
\* = Lk ou L ou P1 ou P2 (Latéral ou Perpendiculaire)

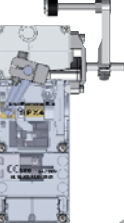
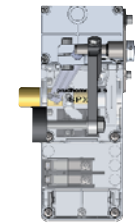
=



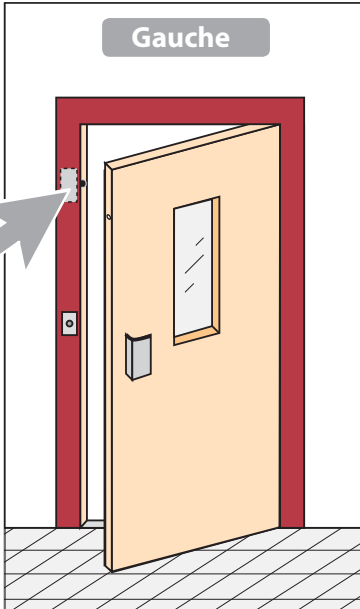

 * = L <sub>k</sub>	 * = L	 * = L <sub>1</sub>	 * = P <sub>1</sub>
 * = P <sub>2</sub>	 * = C	 * = E	

+

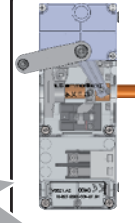
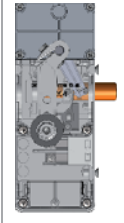

**Gauche**

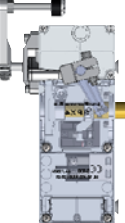
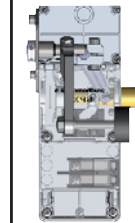
=

 * = L <sub>k</sub>	 * = L	 * = L <sub>1</sub>	 * = P <sub>1</sub>
 * = P <sub>2</sub>	 * = C	 * = E	

+



**Droite**

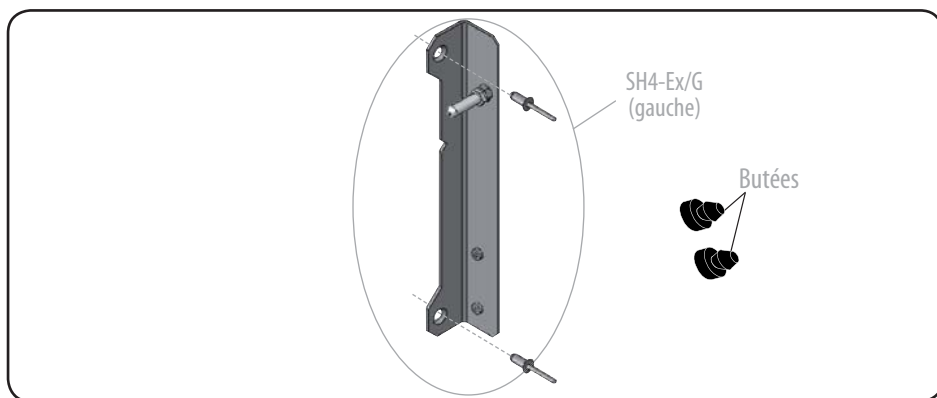

SH4-Ex/G (gauche)

Butées

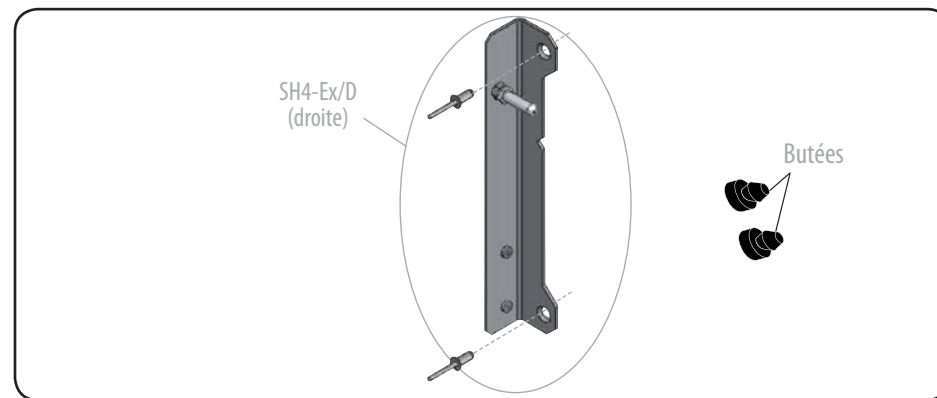

SH4-Ex/D (droite)

Butées

# SPX4-Ex

# Serrure SPX4 sur porte battante en milieu Atex

Serrure certifiée ATEX - groupe II (2GD ; C II BT6)

Phases de montage

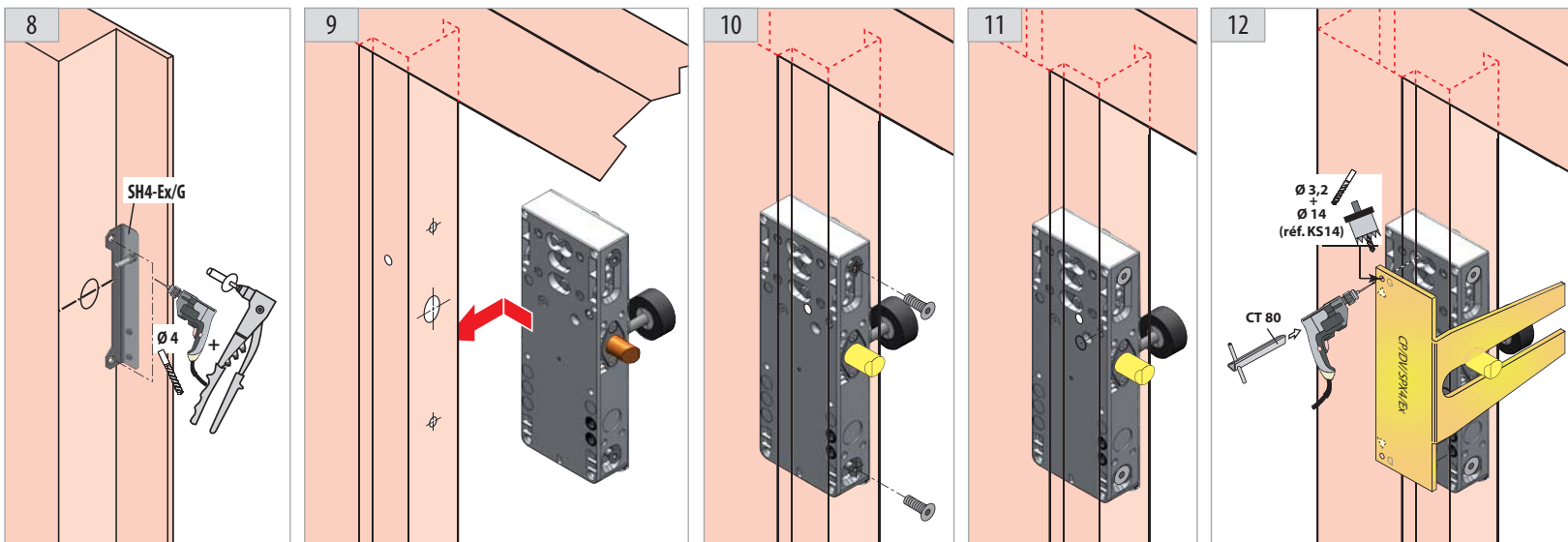
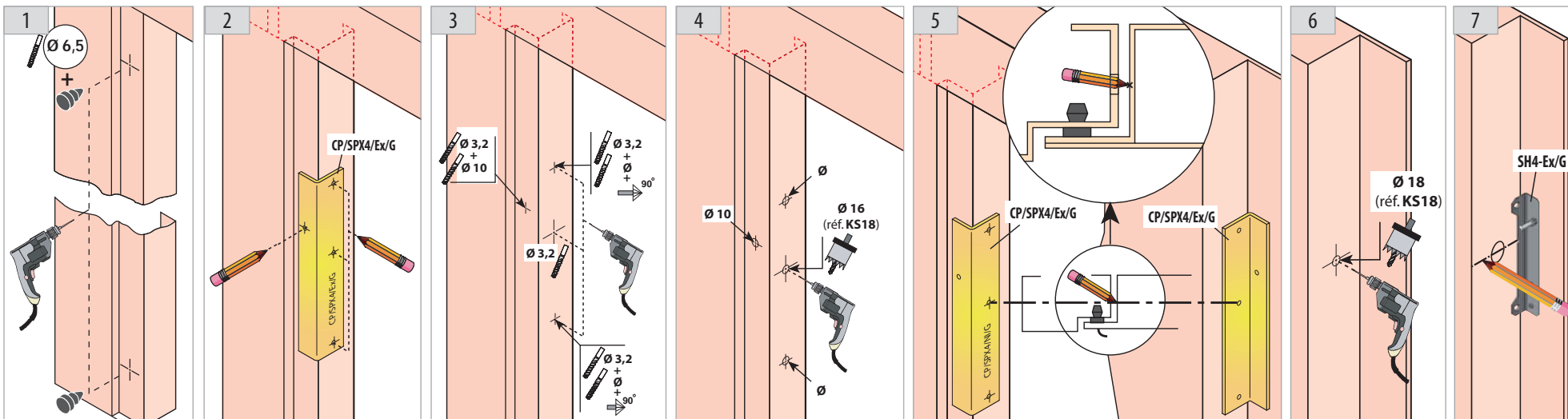
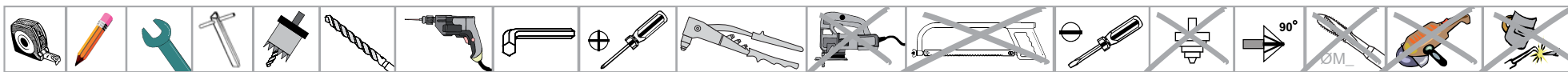

## Information

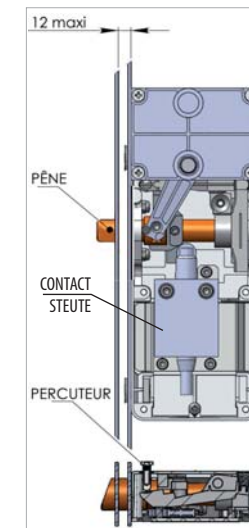

40a 202 FICHE INSTALLATION PRODUIT

Pour portes palieres battantes

Ind. A du 22/09/2014  
FP

Document non contractuel, sous réserve de modification - Reproduction interdite.